

Kreuz-Klemmverbinder

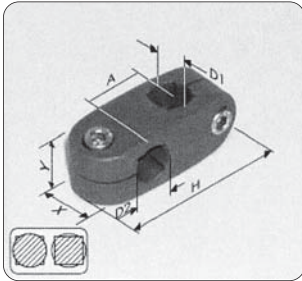

D1 mm		D2 mm		X mm	Y mm	H mm	A mm	Material	Artikel-bezeichnung	Preis Fr.
∅	∅	∅	∅							
10	8	10	8	21	21	53	16	PA	650201	8.-
12	10	12	10	21	21	53	16		650211	8.-

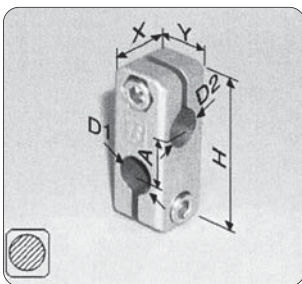

D1 mm	D2 mm	X mm	Y mm	H mm	A mm	Material	Artikel-bezeichnung	Preis Fr.
∅	∅							
12	12	20	20	53	16	Inox 1.43	656834	24.-
12	12	20	20	53	16		621634	18.-
12	14	20	20	53	16		621644	18.-
14	14	20	20	53	16	AL	621654	18.-
15	15	30	30	80	25		621554	21.-
15	16	30	30	80	25		621564	21.-
15	18	30	30	80	25		621574	21.-
16	16	30	30	80	25		621584	23.-
16	18	30	30	80	25		621594	23.-
18	18	30	30	80	25		621604	23.-
20	20	30	30	80	25		621614	23.-
25	25	40	40	90	30		621504	30.-
27	27	40	40	90	30		621514	30.-
25	30	40	40	90	30		621524	30.-

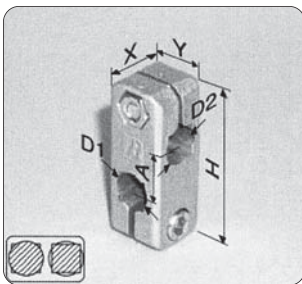

D1 mm	D2 mm	X mm	Y mm	H mm	A mm	Material	Artikel-bezeichnung	Preis Fr.		
∅	∅									
12	10	12	10	20	20	53	16	AL	621624	21.-

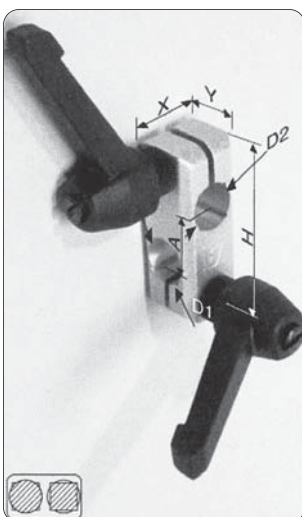

D1 mm	D2 mm	X mm	Y mm	H mm	A mm	Material	Artikel-bezeichnung	Preis Fr.
∅	∅							
16	16	30	30	80	25	AL	655424	53.-

Rabatte:
 ab Fr. 300.-: 10 %
 ab Fr. 600.-: 20 %

Kreuz-Klemmverbinder

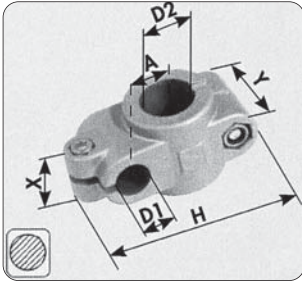

D1 mm ∅	D2 mm ∅	X mm	Y mm	H mm	A mm	Material	Artikel- bezeichnung	Preis Fr.
16	25	40	40	97	33	AL	663276	18.-

Flansch-Klemmverbinder

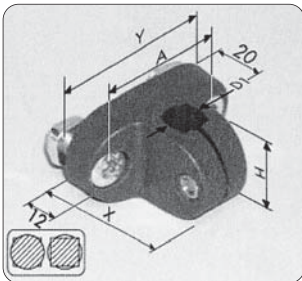

D1 mm ∅	X mm	Y mm	H mm	A mm	Material	Artikel- bezeichnung	Preis Fr.	
12	10	38,5	56	30	40	PA	650191	9.-
12	10	42,2	64	33	40	AL	621704	21.-

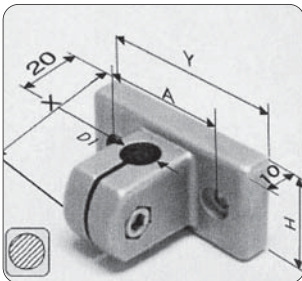

D1 mm ∅	X mm	Y mm	H mm	A mm	Material	Artikel- bezeichnung	Preis Fr.	
12		42,4	64	33	40	AL	621694	18.-
12		42,4	64	33	40	Inox 1.43	656844	40.-
18		55	70	35	45	AL	663084	45.-

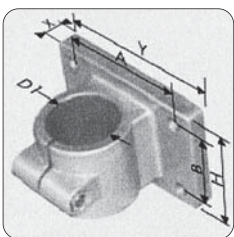

D1 mm ∅	X mm	Y mm	H mm	A mm	B mm	Material	Artikel- bezeichnung	Preis Fr.
20	9	70	52	53	35	AL	602056	22.-
50	14	128	92	98	62		618772	52.-

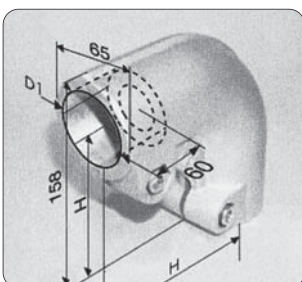

D1 mm ∅	H mm	Material	Artikel- bezeichnung	Preis Fr.
50	123	AL	669463	125.-

Rabatte:
 ab Fr. 300.-: 10 %
 ab Fr. 600.-: 20 %

Laschen-Klemmverbinder

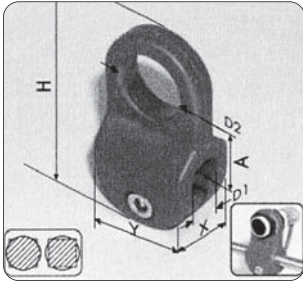

D1 mm	D2 mm	X mm	Y mm	H mm	A mm	Material	Artikel-bezeichnung	Preis Fr.	
10	8	19	21	30	58,5	25	PA	650121	8.-

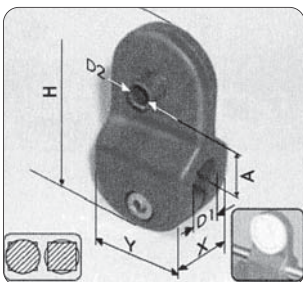

D1 mm	D2 mm	X mm	Y mm	H mm	A mm	Material	Artikel-bezeichnung	Preis Fr.	
10	8	6	21	30	58,5	25	PA	657171	7.-
12	10	6	21	30	58,5	25		657181	7.-

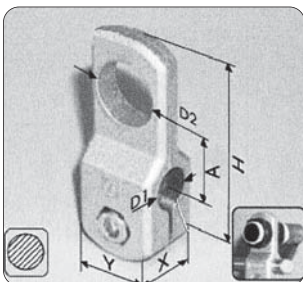

D1 mm	D2 mm	X mm	Y mm	H mm	A mm	Material	Artikel-bezeichnung	Preis Fr.
12	19	20	25	66	26,5	AL	621734	14.-
12	19	20	25	66	26,5	Inox 1.43	656854	29.-

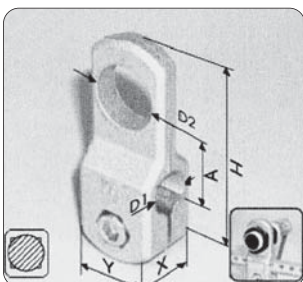

D1 mm	D2 mm	X mm	Y mm	H mm	A mm	Material	Artikel-bezeichnung	Preis Fr.	
12	10	19	20	25	66	26,5	AL	621744	18.-

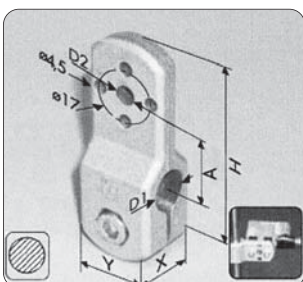

D1 mm	D2 mm	X mm	Y mm	H mm	A mm	Material	Artikel-bezeichnung	Preis Fr.
12	6,2	20	25	66	26,5	AL	621714	14.-

Rabatte:
 ab Fr. 300.-: 10 %
 ab Fr. 600.-: 20 %

Laschen-Klemmverbinder

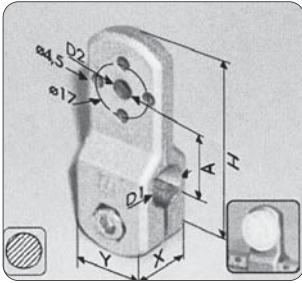

D1 mm	D2 mm	X mm	Y mm	H mm	A mm	Material	Artikel-bezeichnung	Preis Fr.	
12	10	6,2	20	25	66	26,5	AL	621724	18.-

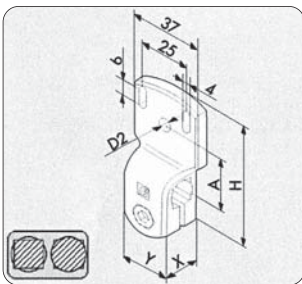

D1 mm	D2 mm	X mm	Y mm	H mm	A mm	Material	Artikel-bezeichnung	Preis Fr.	
12	10	6,2	20	25	66	26,5	AL	646176	15.-

Signalhalterungen für Fotozellen u. ä. (Bausatz)

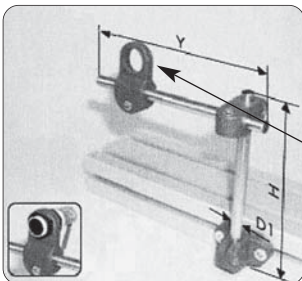

D1 mm			Y mm	H mm		Material	Artikel-bezeichnung	Preis Fr.
10			150	150		PA	60474	39.-
12			150	150		AL	621754	62.-

zusätzlich: Teil Nr. 650121

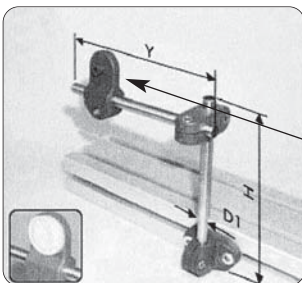

D1 mm		X mm	Y mm	H mm		Material	Artikel-bezeichnung	Preis Fr.
10			150	150		PA	61026	39.-

zusätzlich

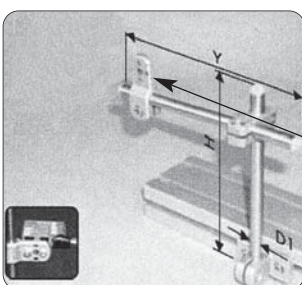

D1 mm			Y mm	H mm		Material	Artikel-bezeichnung	Preis Fr.
12			150	150		AL	602936	62.-

zusätzlich

Rabatte:
 ab Fr. 300.-: 10 %
 ab Fr. 600.-: 20 %

Flansch-Klemmverbinder

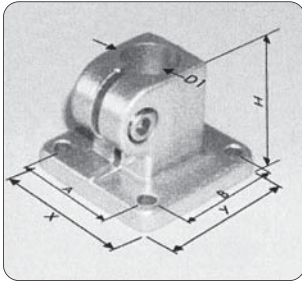

D1 mm	X mm	Y mm	H mm	A mm	B mm	Material	Artikelbezeichnung	Preis Fr.
18	50	50	40	38	38	AL	634593	35.-

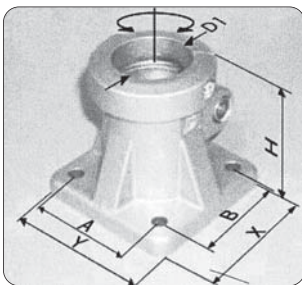

D1 mm	X mm	Y mm	H mm	A mm	B mm	Material	Artikelbezeichnung	Preis Fr.
50	105	105	104	74	74	AL	669663	215.-

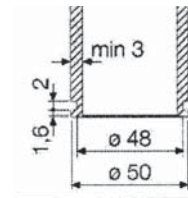

Detail Rohrende

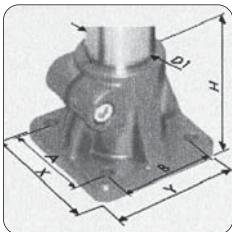

D1 mm	X mm	Y mm	H mm	A mm	B mm	Material	Artikelbezeichnung	Preis Fr.
20	60	60	50	42	42	AL	643754	22.-
25	60	60	50	42	42		643784	22.-
30	60	60	50	42	42		643814	22.-
30	90	90	70	64	64/45		690504	37.-
40	90	90	70	64	64/45		690534	37.-
40	105	105	85	74	74		654464	38.-
50	105	105	85	74	74		643724	38.-
60	126	126	100	90	90		643694	58.-

Rabatte:
 ab Fr. 300.-: 10 %
 ab Fr. 600.-: 20 %

Scharniere Edelstahl 1.4301

Schwenkbereich: 270°

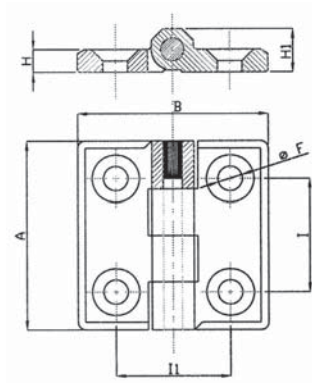
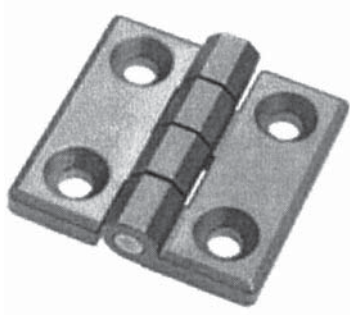

A	B	I	I1	F	H	H1	Artikel- bezeichnung	Preis Fr.
39	39	25	25	5,5	4	9	60000/2S	14.-
50	50	30	30	6,5	6	12	60010/1S	16.-

Rabatte:
 ab Fr. 300.-: 10 %
 ab Fr. 600.-: 20 %

Aufträge unter Fr. 50.-
 mit Dienstleistungszuschlag von Fr. 30.-.

Die Preise verstehen sich ab Werk ohne Verpackung, Fracht und MwSt.
 Preis- und technische Änderungen vorbehalten.